



qubino®

WIRELESS SMART HOME

USER MANUAL **EN**

QUBINO 3-PHASE SMART METER



The Qubino 3-Phase Smart Meter is an extremely versatile and powerful Z-Wave device for measuring energy in a three-phase electrical power network of up to 3 x 65A.

Table of contents

Table of contents	2
About Qubino.....	4
Safety Information	6
3-Phase Smart Meter - Available Frequencies.....	7
Where To Buy.....	8
1. Introduction	8
2. Use Cases	10
2.1. Installation examples for the 3-Phase Smart Meter - used for measuring consumption .	10
2.1. Installation examples for the 3-Phase Smart Meter - used for measuring consumption and controlling* electrical devices	11
2.2. Additional features of 3-Phase Smart Meter which can make your life easier	13
3. Qubino 3-Phase Smart Meter Advantages and Highlights	14
4. Package Contents.....	19
5. Technical Terms for Switches	20
6. Compatibility with Z-Wave Gateways (hubs)	21
7. Installation	22
8. Device Information and Support	32
9. Electrical Diagram 3 X 230VAC.....	33
10. Adding the device to a Z-Wave network (Inclusion).....	39
11. Removing the device from a Z-Wave network (Exclusion).....	40
LED1 (Green)	41
LED2 (Yellow)	41
12. Associations	42
13. Configuration Parameters.....	44
Parameter no. 43 – Other Values - Reporting on time interval	46
Parameter no. 100 – Enable / Disable External IR relay (BICOM)	47
Parameter no. 101 – Enable / Disable External relay (IKA)	47
14. Technical Specifications	50

15. Z-Wave Command Classes 53

16. Z-Wave Security 59

17. Important Disclaimer 60

18. Warning..... 60

19. Regulations..... 60

About Z-Wave:

The Z-Wave protocol is an interoperable, wireless, RF-based communications technology designed specifically for control, monitoring, and status reading applications in residential and light commercial environments. Mature, proven, and broadly deployed (with over 50 million products sold worldwide), Z-Wave is by far the world market leader in wireless control, bringing affordable, reliable, and easy-to-use 'smart' products to millions of people in every aspect of daily life.

Source: www.z-wavealliance.org

Safety Information

For Qubino, safety is first, so we have prepared lots of safety tips and information that can be found throughout this manual.

To ensure your safety, please read this manual carefully before installing the device; follow the instructions exactly. The manufacturer (GOAP d.o.o. Nova Gorica) shall not be legally responsible for any equipment damage or personal injury caused by incorrect installation or operation other than that covered in this manual.

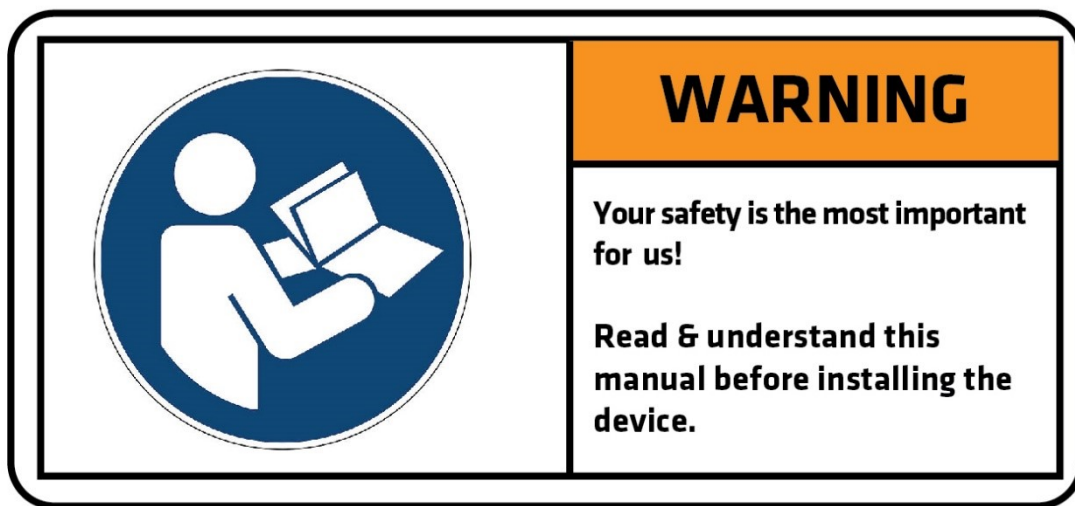

i Please check the Technical Specifications and Electrical Diagram chapters, as well as fuse requirements in the Installation chapter before installing the device.

3-Phase Smart Meter - Available Frequencies

ORDERING CODE (MODEL NUMBER)	POWER SUPPLY FREQUENCY	Z-WAVE FREQUENCY*
ZMNHXD1	50/60 Hz	868,4 MHz
ZMNHXD2	50/60 Hz	921,4 MHz
ZMNHXD3	50/60 Hz	908,4 MHz
ZMNHXD4	50/60 Hz	869,0 MHz
ZMNHXD5	50/60 Hz	916,0 MHz
ZMNHXD7	50/60 Hz	919,8 MHz
ZMNHXD8	50/60 Hz	865,2 MHz
ZMNHXD9	50/60 Hz	922,5 MHz
ZMNHXDA	50/60 Hz	919,7 – 921,7 – 923,7 MHz

 PLEASE NOTE THAT 3-PHASE SMART METER WORKS ONLY ON 230VAC +15/-20%.

*You can check the Z-Wave frequency in your country here:
<https://www.silabs.com/products/wireless/mesh-networking/z-wave/benefits/technology/global-regions>

Where To Buy

To find your nearest Qubino dealer visit: <http://qubino.com/where-to-buy/>

1. Introduction

Qubino 3-Phase Smart Meter is used for energy measurements in three-phase electrical power network and can be used in residential, industrial and utility applications. The device measures energy directly in 4-wire networks according to the principle of fast sampling of voltage and current signals. It is designed to be mounted on DIN rail.

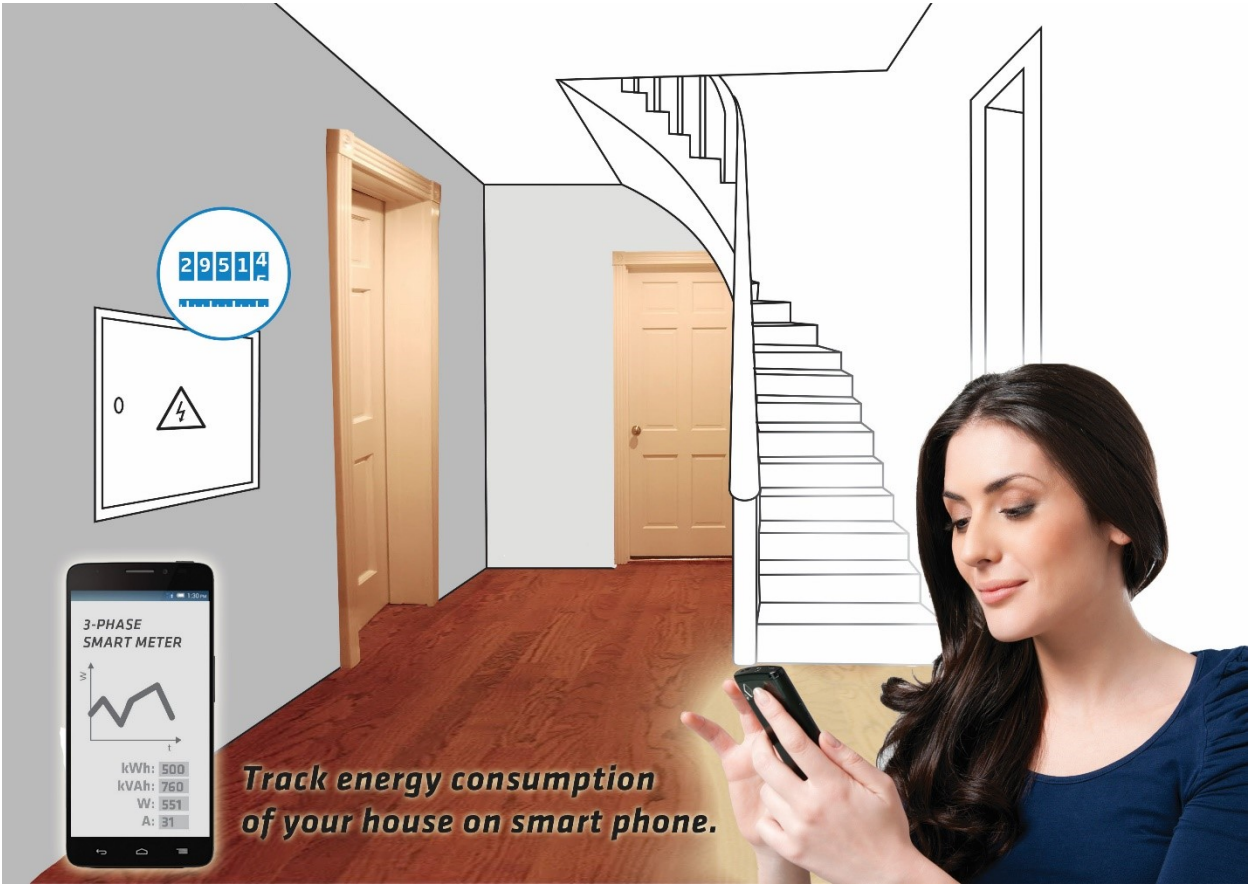

The Qubino 3-Phase Smart Meter device can operate across a wide temperature range, from a chilly -25°C to a scorching 55°C (-13F° to a scorching 131°F). Every device also acts as a repeater in order to improve the range and stability of the Z-Wave network.

3-Phase Smart Meter measurements:

Voltage [V]	Current [A]	Power – Active [W]	Power – Reactive [var]	Power Factor – [PF]	Energy – Active power accumulated Import [kWh]	Energy – Active power accumulated Export[kWh]	Energy – Apparent power accumulated [kVAh]	Energy – Reactive power accumulated [kvarh]
✓	✓	✓	✓	✓	✓	✓	✓	✓

Optional: 3-Phase Smart Meter supported functions:

Turn ON/OFF device 1*	Turn ON/OFF device 2*	Automatically turn ON/OFF*	Z-Wave Repeater	Auto-inclusion
✓	✓	✓	✓	✓

*with additional external contactors - IKA/BICOM. IKA and BICOM are sold separately - for more info, please see Qubino catalogue. Product ordering codes (model numbers): IKA232-20/230V: 030 046 833 000; BICOM432-40-WM1: 30.074.038



2. Use Cases

The 3-Phase Smart Meter can be used in many different scenes, which can help make your life more comfortable. We have prepared a few of them for you-so you can get an idea for your next smart home project. Of course, there are countless of other options for how to use Qubino 3-Phase Smart Meter to remotely control devices via your smartphone.

2.1. Installation examples for the 3-Phase Smart Meter - used for measuring consumption

<ul style="list-style-type: none"> Track power consumption of the house <p>Measuring</p> <p>V A W var PF kWh import kWh export kvarh</p>	<ul style="list-style-type: none"> Track power consumption of one 3-phase electrical device (for example: 3-phase heat pump) <p>Measuring</p> <p>V A W var PF kVAh kWh import kWh export kvarh</p>
<ul style="list-style-type: none"> Track power consumption of one 3-phase electrical device (for example: induction cooktop) <p>Measuring</p> <p>V A W var PF kVAh kWh import kWh export kvarh</p>	<ul style="list-style-type: none"> Measure 3 different el. values (V,A,W) on each phase, plus 5 el. values in common (kWh,var,kvarh,kVAh,PF) <p>Measuring</p> <p>V A W var PF kVAh kWh import kWh export kvarh</p>

- Track the power generated by the solar power plant

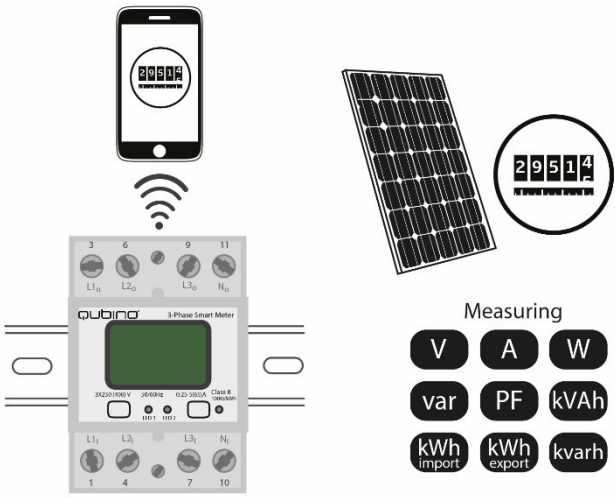

- Track the power consumed from the electrical power network and power exported in electrical power network

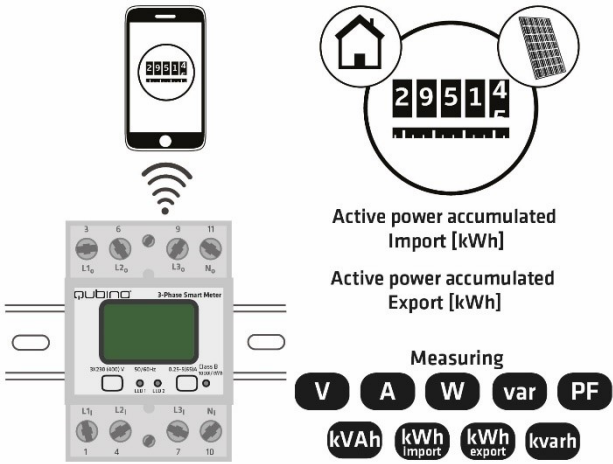

2.1. Installation examples for the 3-Phase Smart Meter - used for measuring consumption and controlling* electrical devices

(*with additional external contactors - IKA/BICOM. IKA and BICOM are sold separately - for more info, please see Qubino catalogue. Product ordering codes (model numbers): IKA232-20/230V: 030 046 833 000; BICOM432-40-WM1: 30.074.038)

- Remotely control and measure 3-phase power consumption of one electrical device (for example: heat pump) – with BICOM432-40-WM1

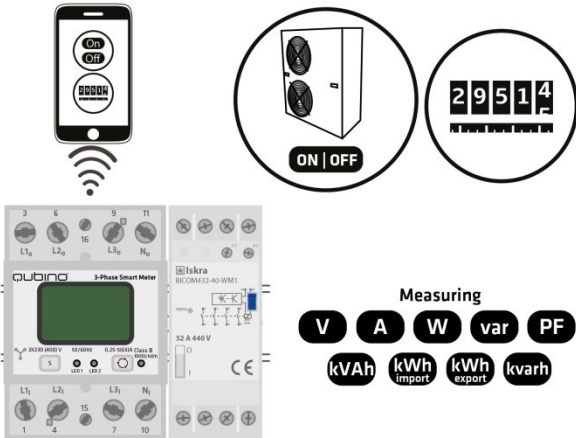

- Remotely control and measure 3-phase power consumption of one electrical device (for example: oven) – with BICOM432-40-WM1

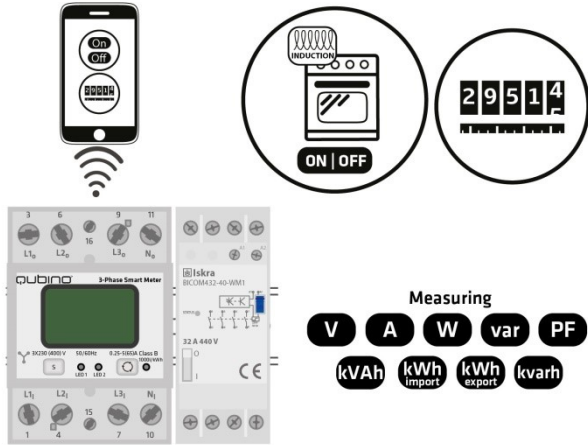

- Remotely control and measure 3-phase power consumption of one electrical device (for example: accurate information of electrical car energy consumption) – with BICOM432-40-WM1

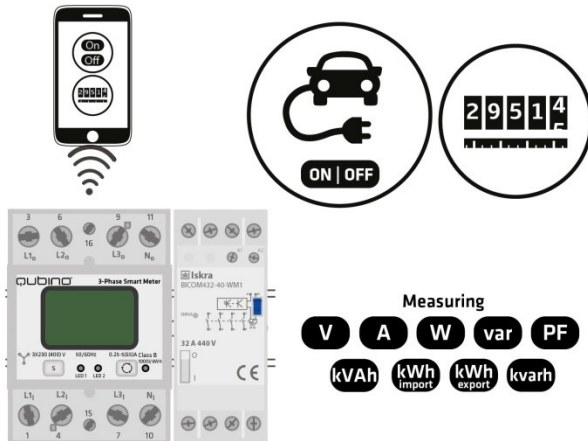

- Remotely measure power consumption of whole house and control one group of electrical devices (for example: lights) – with IKA232-20/230V

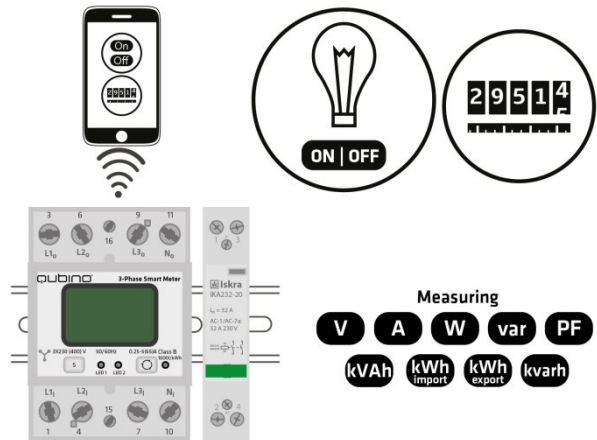

- Track power consumption for each of three electrical devices and control two groups of electrical devices (for example: 3-phase heat pump and lights) – with BICOM432-40-WM1 and IKA232-20/230V

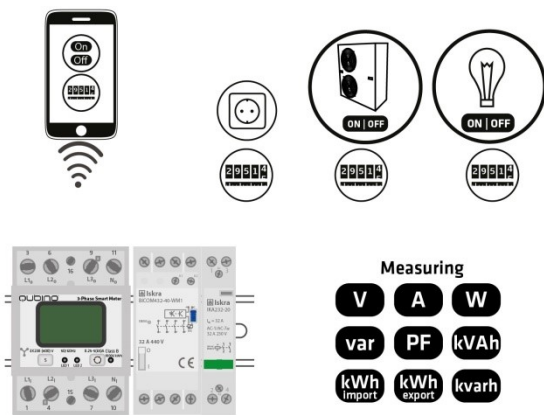

- Remotely measure power consumption of whole house and control two groups electrical devices (for example: 3-phase heat pump and lights) – with BICOM432-40-WM1 and IKA232-20/230V

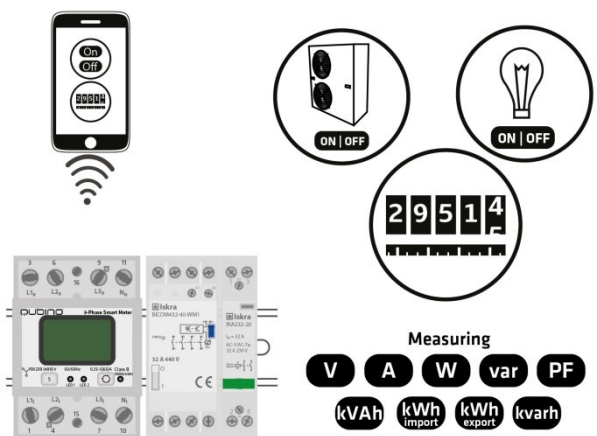

2.2. Additional features of 3-Phase Smart Meter which can make your life easier

Do you often notice that some devices in your household consume too much energy?

The 3-Phase Smart Meter can automatically turn devices/lights off after they exceed the set power consumption. For example, the heating will automatically turn off after it reaches the set power consumption value. This function is independent of other scenes and gateway (hub) commands.

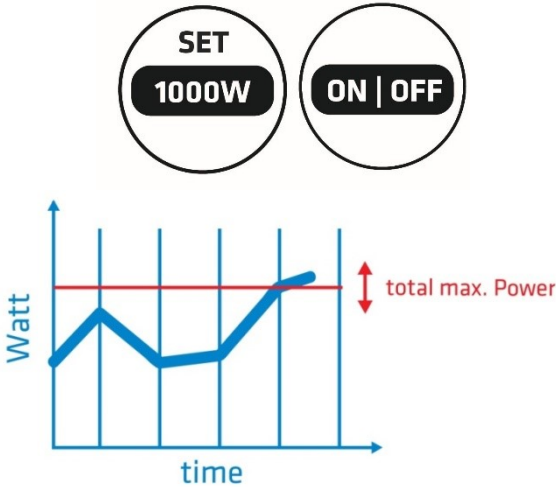

Want to control other devices in your Z-Wave network with the 3-Phase Smart Meter?

Connect the 3-Phase Smart Meter with other devices in your network to remotely and automatically trigger another Z-Wave device. And have other Z-Wave devices trigger your Qubino 3-Phase Smart Meter.



3. Qubino 3-Phase Smart Meter Advantages and Highlights

- The Qubino 3-Phase Smart Meter is **the most accurate Z-Wave 3-Phase Smart Meter in the world**. It is the only Z-Wave 3-Phase Smart Meter where the current is measured by passing through the device – not through clamps. Measuring the electric consumption with a smart meter using clamps, is not as accurate as it is, if the electricity passes through the device.

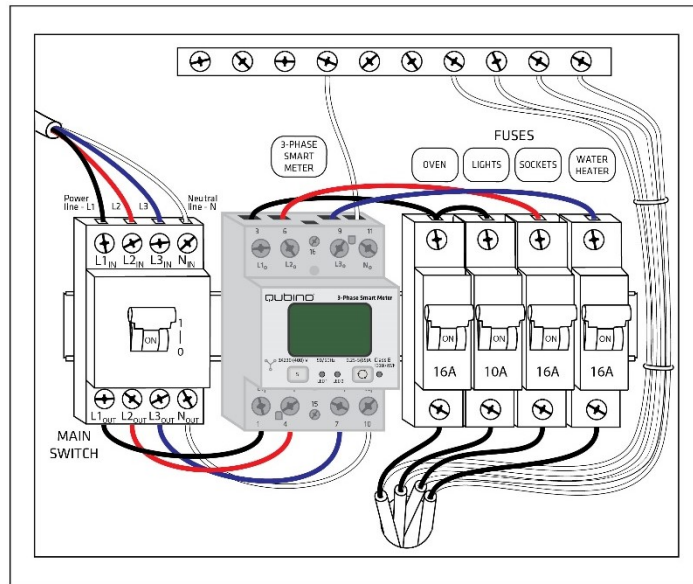

- The only Z-Wave 3-Phase Smart Meter in the world that supports **Z-Wave S2 Authenticated secure inclusion**.

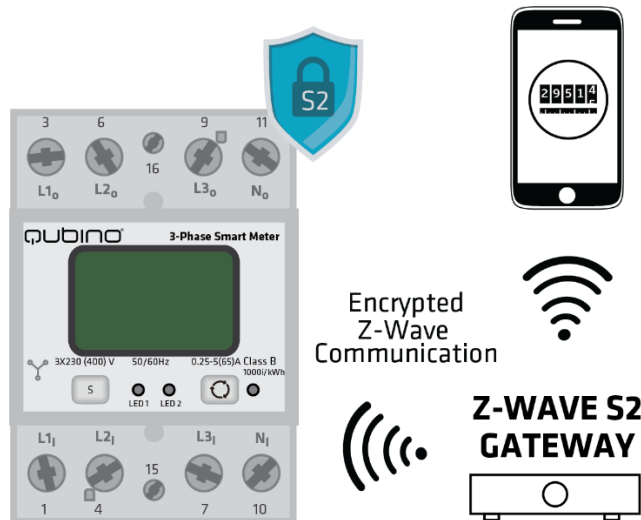

- The Qubino 3-Phase Smart Meter allows the **easiest and quickest installation possible**. There is no simpler installation than **DIN rail installation** – and the Qubino 3-Phase Smart Meter is a DIN rail mounted device so the installation is really simple.

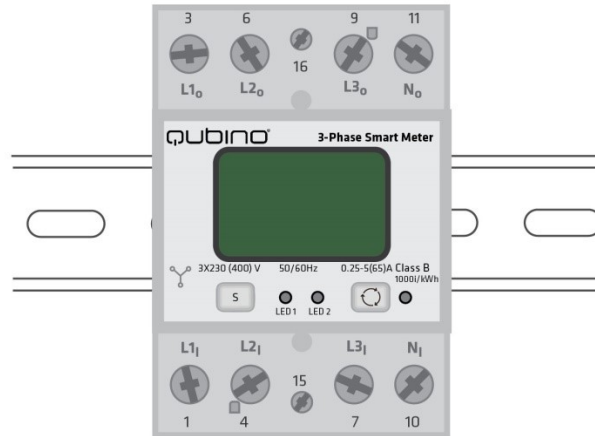

- The Qubino 3-Phase Smart Meter is the only 3-phase smart meter worldwide that beside measuring allows you to switch ON/OFF two independent electrical circuits, by connecting two additional contactors - IKA/BICOM. IKA and BICOM are sold separately - for more info, please see Qubino catalogue.
Product ordering codes (model numbers): IKA232-20/230V: 030 046 833 000; BICOM432-40-WM1: 30.074.038

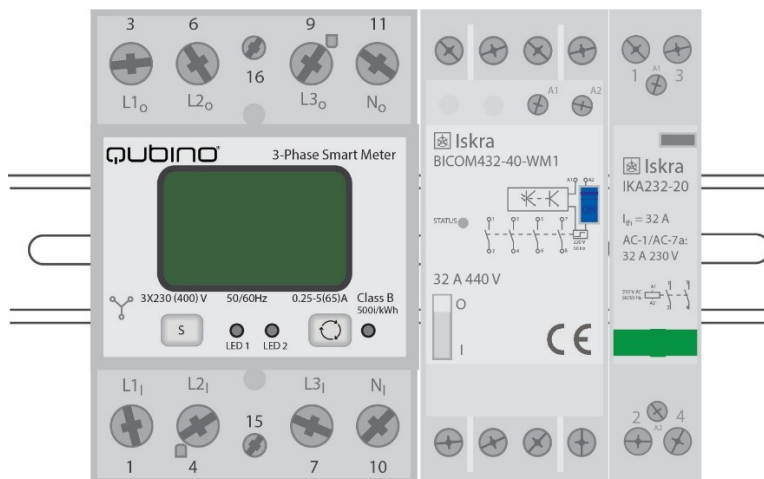

- Qubino 3-Phase Smart Meter can measure: Voltage [V], Current [A], Power – Active [W], Power – Reactive [var], Power Factor – [PF], Energy – Active power accumulated Import [kWh], Energy – Active power accumulated Export[kWh], Energy – Apparent power accumulated [kVAh], Energy – Reactive power accumulated [kvarh]

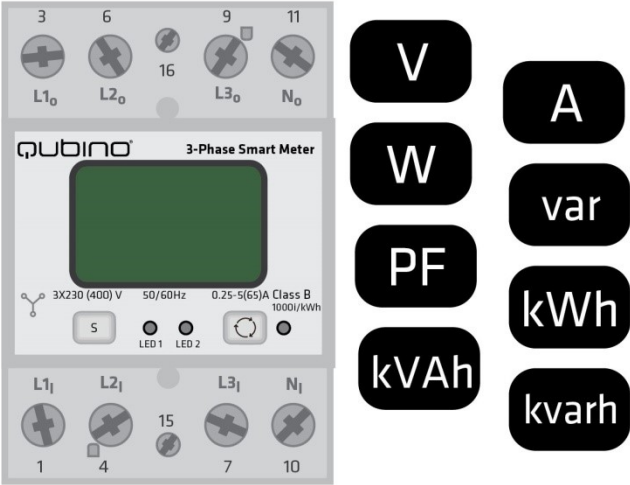

- Qubino guarantees **100% device quality**. Such high quality can be delivered because every Qubino goes through rigorous quality control standards throughout the production process. Every device has a unique serial number and a part number, which are assigned to the device only after it goes through a strict testing procedure.

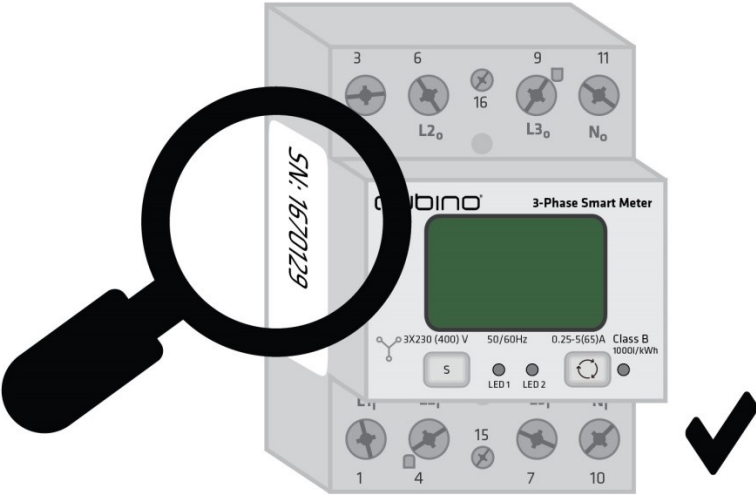

- By scanning the QR code on the back of your Qubino device, the serial and part numbers will be automatically copied on your mobile phone; they also provide **direct access to**

Qubino's technical support team. The serial and part numbers of your device are given automatically every time you open an inquiry with our support team: this instantly shares the relevant device information we need to provide the best technical support possible. For details, please see the Device Information and Support chapter.

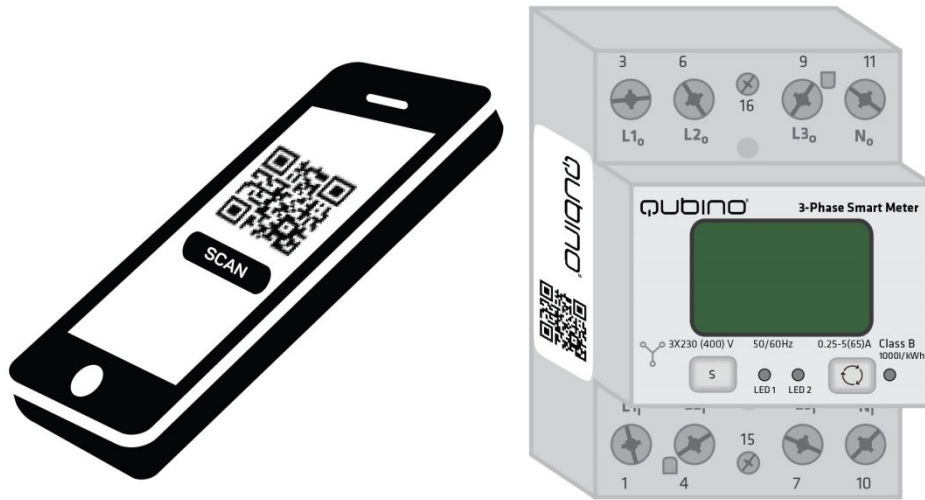

- The Qubino 3-Phase Smart Meter is **engineered and manufactured in the EU**, and contains only the highest quality components.



- The Qubino 3-Phase Smart Meter is certified by an independent European Institute and has CE, LVD and EMC certificates to ensure the highest safety standards.



3-PHASE SMART METER HIGHLIGHTS:







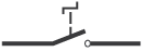

- Use the optional contactor or bi-stable switch with the 3-Phase Smart Meter to facilitate the switching of power circuits or appliances
- Ideal for fast switching of motors, electric heating and lights
- Highly accurate monitoring and energy measurements
- Features one of the easiest and quickest installations of devices of this kind; DIN rail installation
- Saves and restores the last status after a power failure
- Supports auto-inclusion mode for quick set up
- Can automatically turn devices on and off after a set period of time (helpful when you're away from home, for example)*
- Supports additional parameters for expert users, which allows for advanced configuration*
- Acts as a signal repeater which improves the range and stability of your Z-Wave network
- Can be used to remotely control and trigger other devices in your Z-Wave network

*Your gateway (hub) needs to support advanced configuration and parameter input if you wish to use this feature

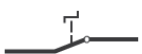
4. Package Contents

- 3-Phase Smart Meter Device
- Installation Manual
- S2 packaging label

5. Technical Terms for Switches

Symbol	Switch example images	Definition	EU	USA	Qubino	Other names
		Single pole, single throw (SPST) - One switch controlling one light / circuit of lights	One-way switch	Two-way switch (regular switch)	Toggle switch	Switch; Bi-stable switch
		Single pole, double throw (SPDT) - Two switches controlling the same light / circuit of lights	Two-way switch	Three-way switch	Two-way switch	
		Used when you have three or more switches controlling the same light	Intermediate switch	Four-way switch	Intermediate switch	Crossover switch; Cross connection
		After being released, it goes back to its original state	Momentary switch		Momentary switch	Monostable switch; Push button

6. Compatibility with Z-Wave Gateways (hubs)

Please check compatibility with your Z-Wave gateway (hub) before you purchase this device. The compatibility table is available online.

https://qubino.com/manuals/Compatibility_with_gateways/Compatibility_manual_3-Phase_Smart_Meter_11092019.pdf

7. Installation

Before installing the device, please read the following carefully and follow the instructions exactly:

ⓘ Danger of electrocution!

Installation of this device requires a great degree of skill and may be performed only by a licensed and qualified electrician. Please keep in mind that even when the device is turned off, voltage may still be present in the device's terminals.

ⓘ Note!

Do not connect the device to loads exceeding the recommended values. Connect the device exactly as shown in the provided diagrams. Improper wiring may be dangerous and result in equipment damage.

Electrical installation must be protected by directly associated overcurrent protection fuse with rated current up to 65A, it must be used according to wiring diagram to achieve appropriate overload protection of the device.

The installation process, tested and approved by professional electricians, consists of the following simple steps:

Step 1 – Turn OFF the fuse:

- To prevent electrical shock and/or equipment damage, disconnect electrical power at the main fuse or circuit breaker before installation and maintenance.
- Be aware that even if the circuit breaker is off, some voltage may remain in the wires — before proceeding with the installation, be sure no voltage is present in the wiring.
- Take extra precautions to avoid accidentally turning the device on during installation.

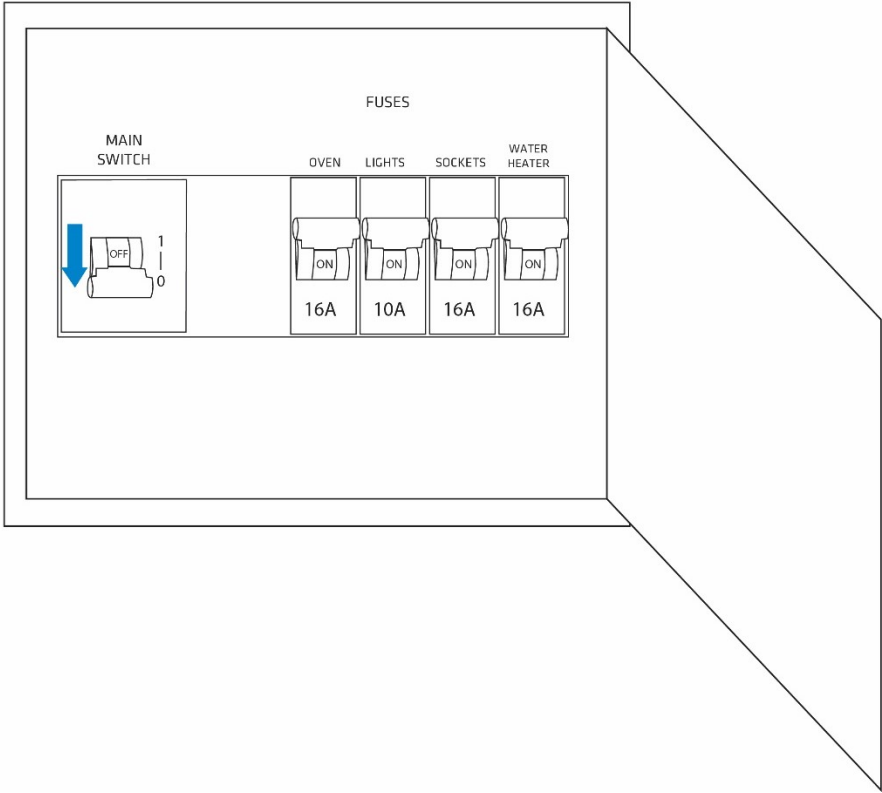

Step 2 – Installing the device:

- Connect the device exactly according to the diagrams shown below

Before Qubino installation:

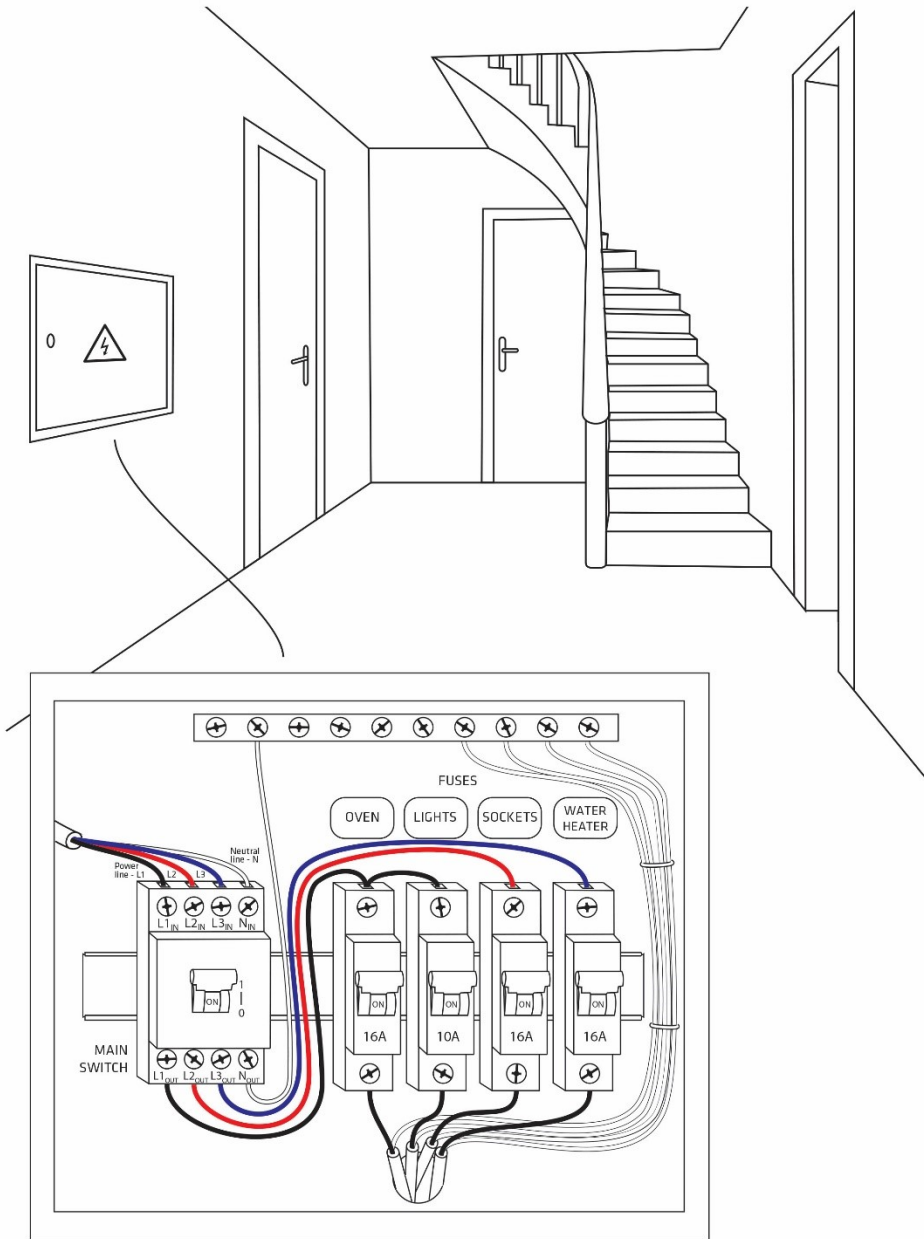

After the Qubino installation:

For measuring the energy of the house:

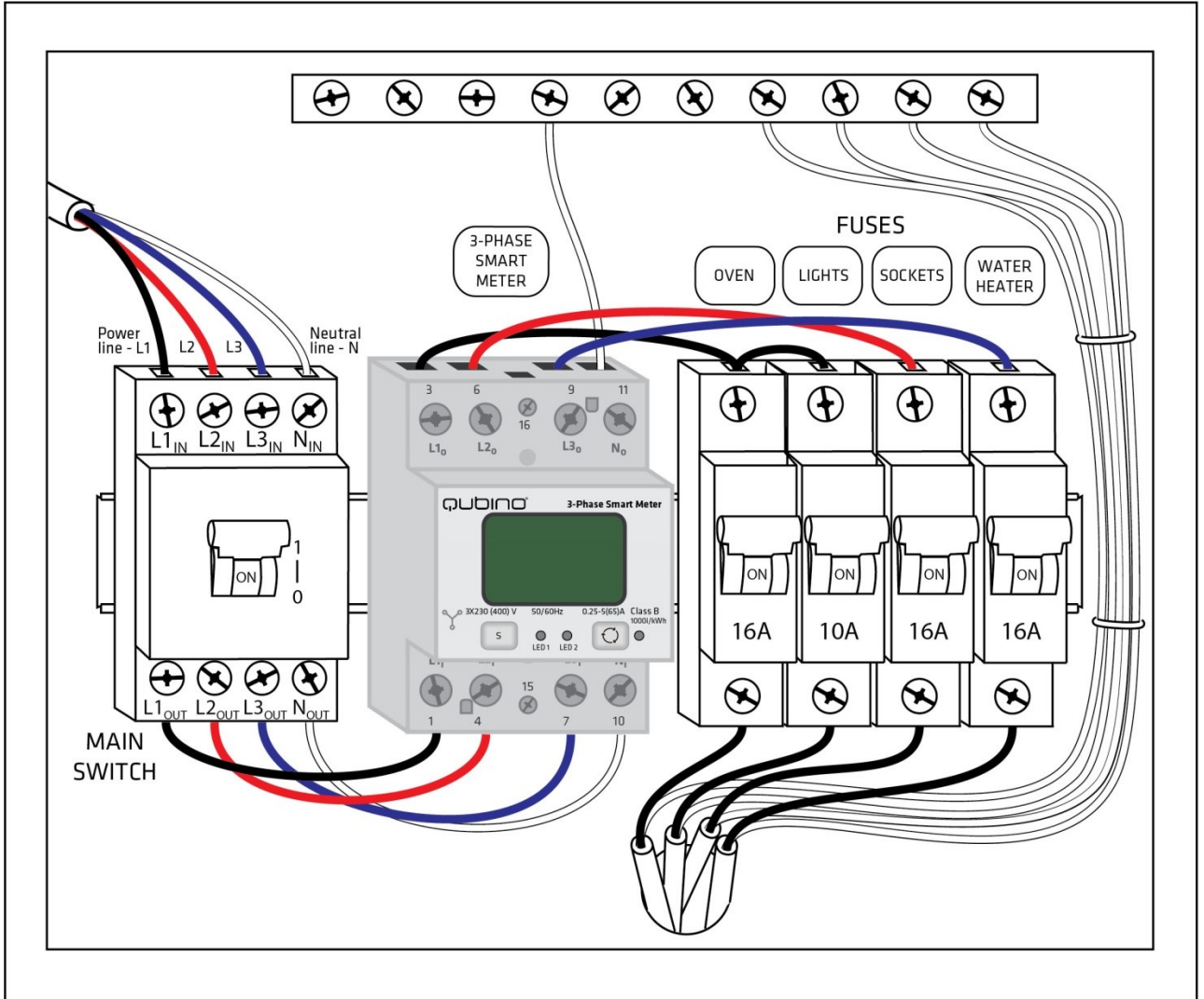

For controlling one electrical device with BICOM432-40-WM1*:

*BICOM is sold separately - for more info, please see Qubino catalogue. Product ordering code (model number): 30.074.038

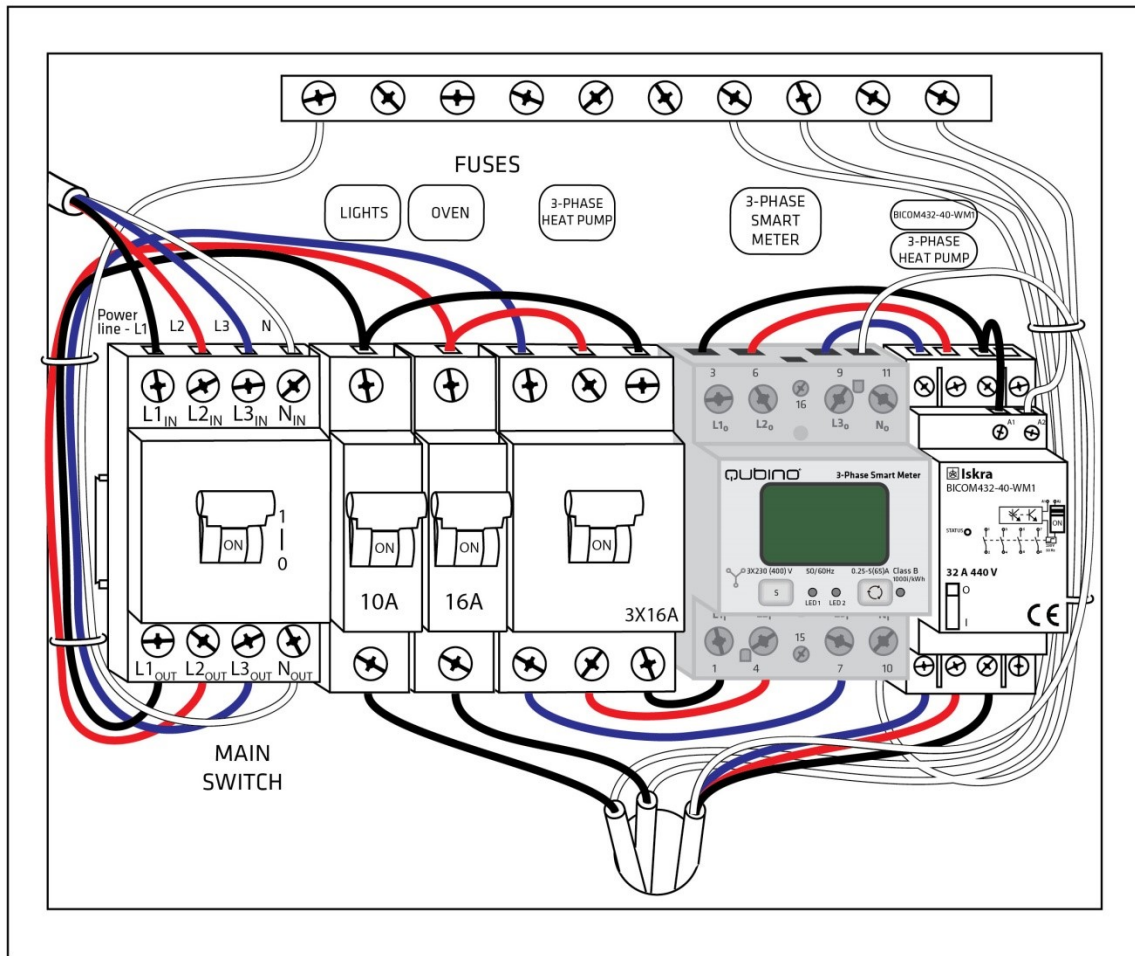

For controlling one electrical device with IKA232-20/230V:

*IKA is sold separately - for more info, please see Qubino catalogue. Product ordering code (model number): 030 046 833 000

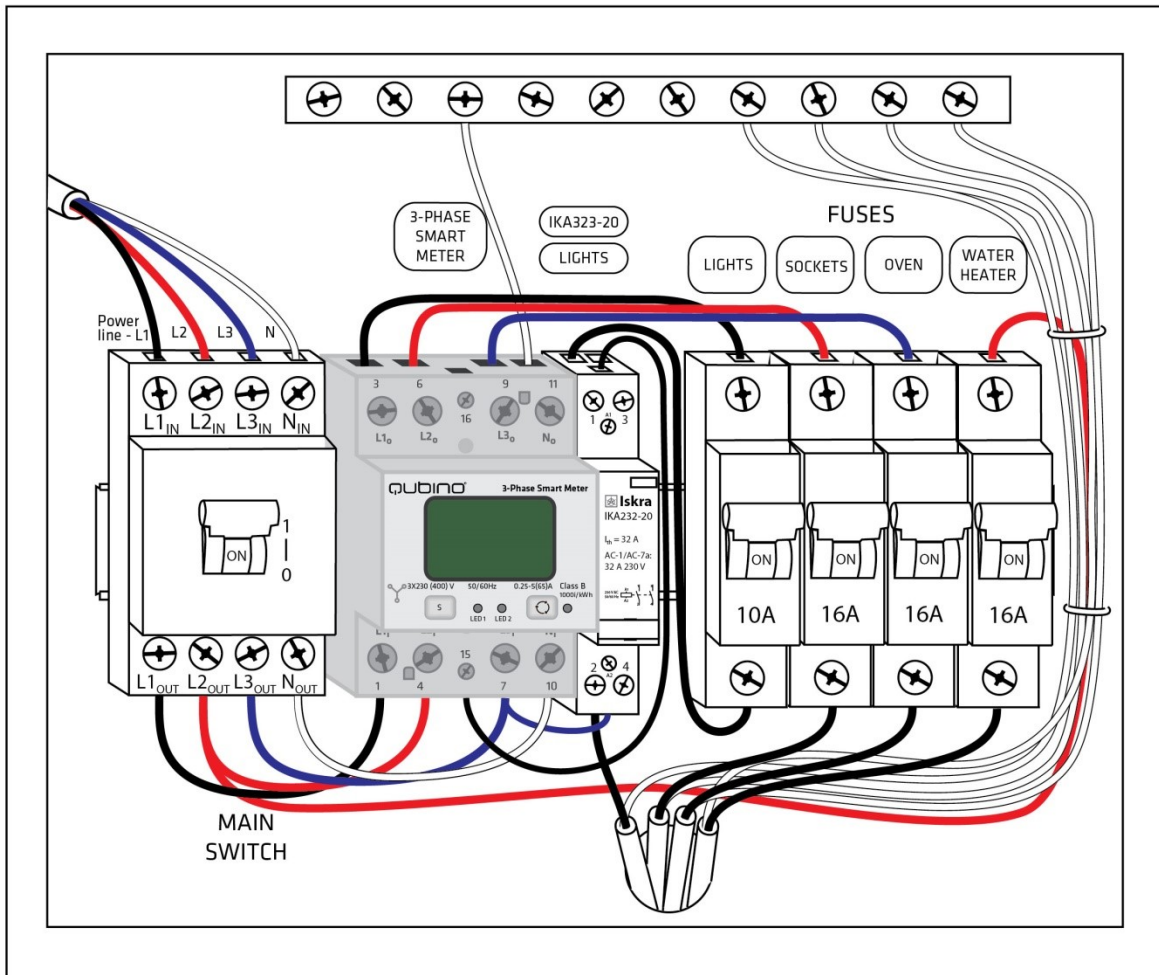

For controlling electrical devices with IKA232-20/230V and one with BICOM432-40-WM1:

*with additional external contactors - IKA/BICOM. IKA and BICOM are sold separately - for more info, please see Qubino catalogue. Product ordering codes (model numbers): IKA232-20/230V: 030 046 833 000; BICOM432-40-WM1: 30.074.038

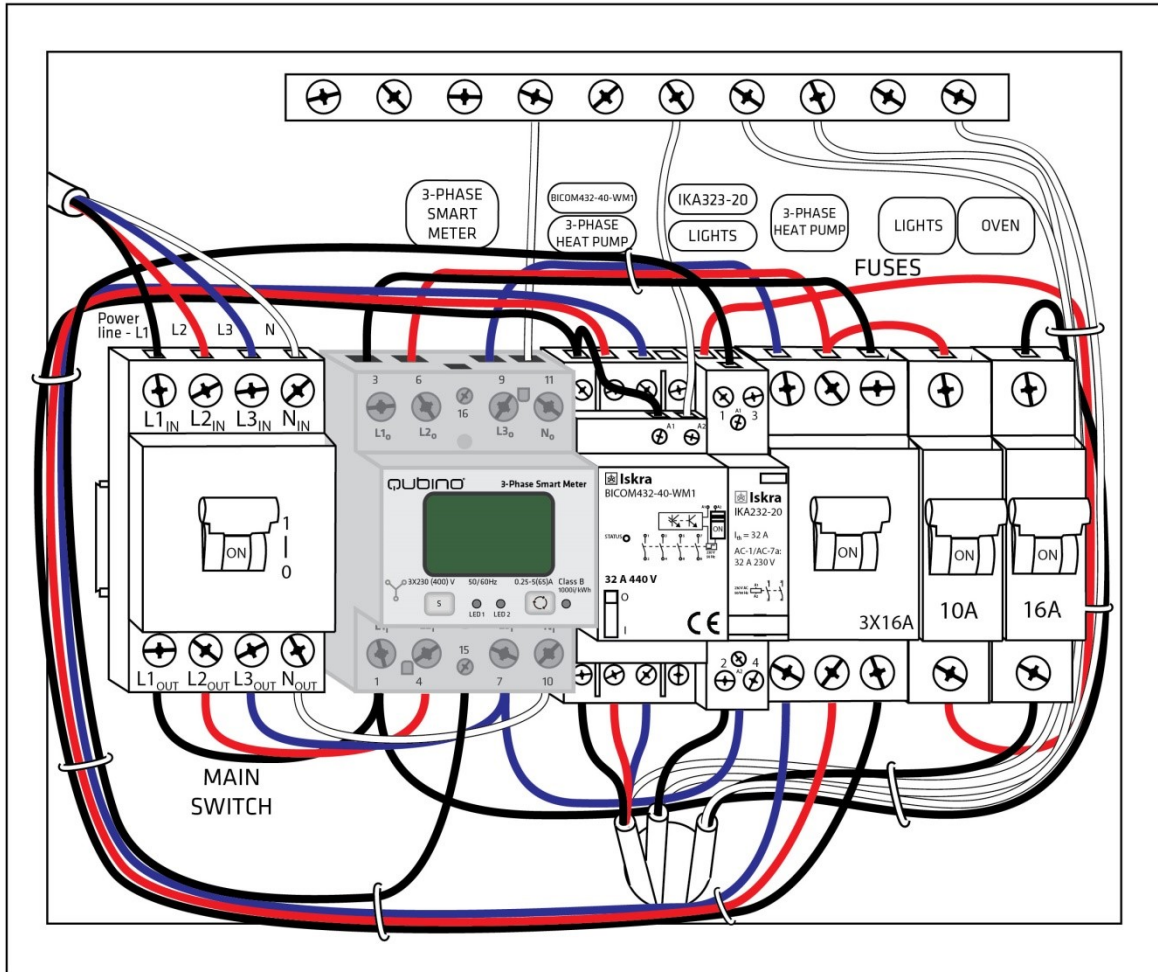

Note!

The DSK code is used to include the device into the Z-Wave network. Once the device will be mounted, access to the DSK code label may be difficult, so we suggest rewriting the DSK code or scanning the QR code from the device label, before installing the device in electric box.

Step 3 – Turn ON the fuse:

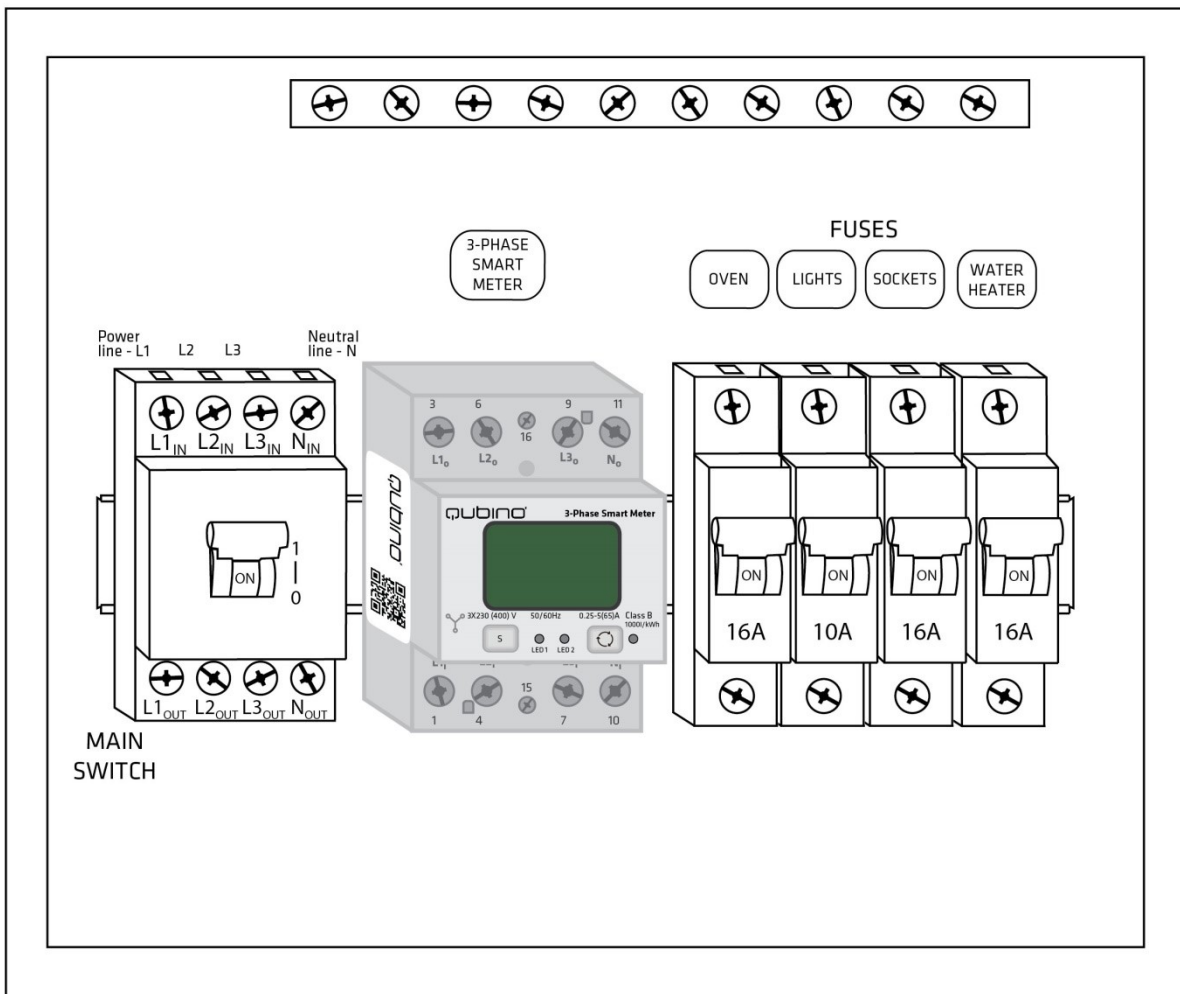

Step 4 – Add the device to your Z-Wave network:

- For more details on how to include the device, please refer to the Z-Wave Inclusion chapter.



Step 5 – The Installation is now complete. It’s time to make your life more comfortable with the help of the Qubino 3-Phase Smart Meter

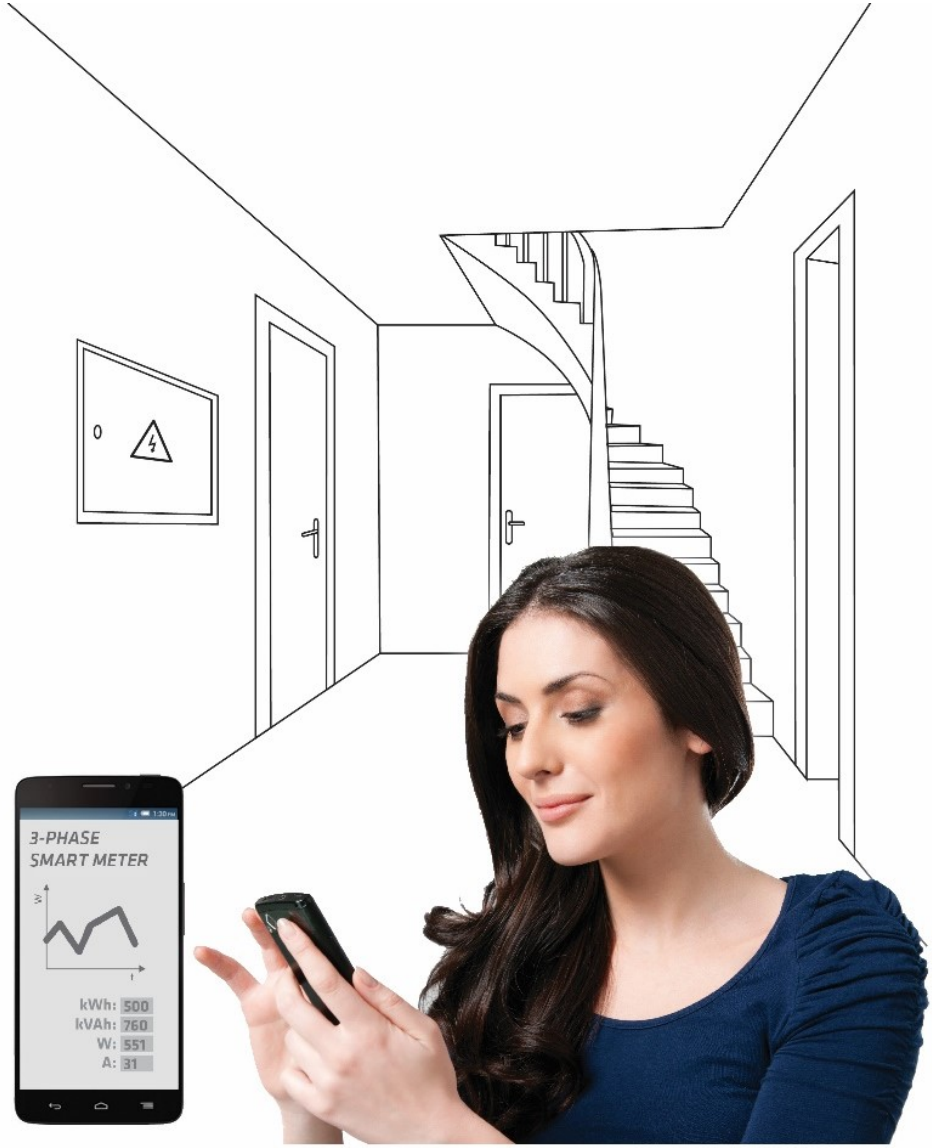

8. Device Information and Support

Did you know that Qubino offers Z-Wave devices with 100% quality control guaranteed throughout the production process? Every single unit is tested and examined before being approved for sale – a truly unique pledge in the industry.

Why is this important?

Every device has a dedicated serial number and part number, which is assigned to the device only after it goes through a strict testing procedure.

Our support policy advises that every customer receives an answer within 24 hours.

Go to our support website <https://support.qubino.com/support/home> and open a new support ticket. By telling us the product's unique serial number and part number, we will automatically review the production log file containing device parameters and information. This allows us to immediately identify and address issues, giving you the best customer support.

Based on customer and business partner feedback, we're proud to boast Qubino's support team as the best and fastest on the market. If you don't find the answers to your questions in this document, please contact us. We will try to help you as soon as possible.

9. Electrical Diagram 3 X 230VAC

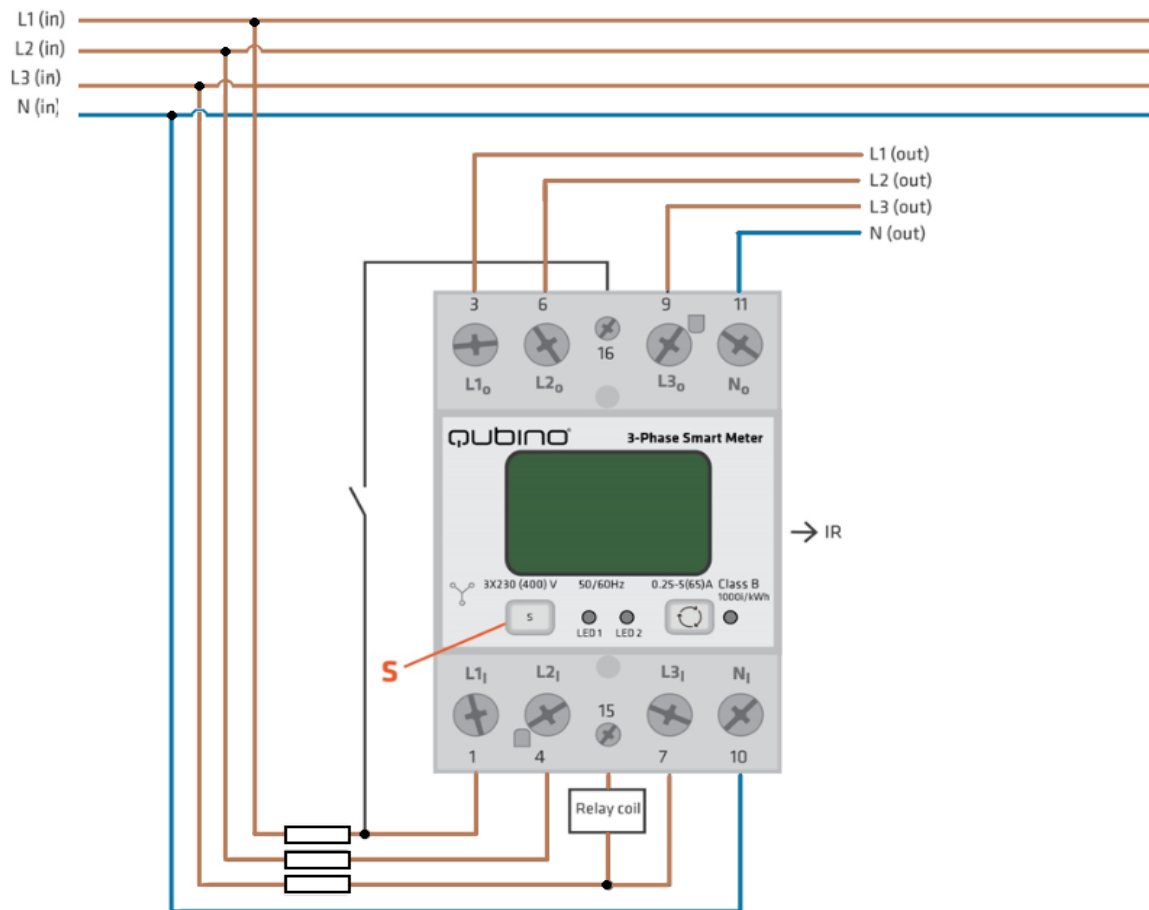

Notes for diagram:

L1_i, L2_i, L3_i	Live input
N_i	Neutral input
L1_o, L2_o, L3_o	Live output
N_o	Neutral output
16	Input for IR external relay/Ext. relay
15	Output for External relay (max. 3W)
S	Service button (used to add or remove device from the Z-Wave network)
LED1	Device status. For detailed information please check the chapter "LED SIGNALIZATION FOR INCLUSION/EXCLUSION"
LED2	External relay status. For detailed information please check chapter LED SIGNALIZATION FOR INCLUSION/EXCLUSION
IR	Output for IR external relay (BICOM)
1000imp/Wh	Red - Pulse rate (On – no load indication)

MEASUREMENTS:

V	Voltage (U1, U2, U3)
A	Current (I1, I2,I3)
W	Power – Active (P1, P2, P3 and total P1+P2+P3)
var	Power – Reactive total (P1, P2, P3 and total P1+P2+P3)
PF	Power Factor (P1, P2, P3 and total P1+P2+P3)
kWh	Energy – Active power accumulated Import
kWh	Energy – Active power accumulated Export
kVAh	Energy – Apparent power accumulated total
kvarh	Energy – Reactive power accumulated total

3 PHASE SMART METER SUPPORTED UNITS

RateType= Import (consumption)								
	Total kWh	Total kVAh	Watt	Voltage	Current	Power Factor	Kvar	Total Kvarh
ROOT(L1+L2+L3) *1	✓	✓	✓	✗	✗	✓	✓	✓
Endpoint 1 (L1+L2+L3)	✓	✓	✓	✗	✗	✓	✓	✓
Endpoint 2 – L1	✗	✗	✓	✓	✓	✓	✓	✗
Endpoint 3 – L2	✗	✗	✓	✓	✓	✓	✓	✗
Endpoint 4 – L3	✗	✗	✓	✓	✓	✓	✓	✗

RateType= Export (generation)								
	Total kWh	Total kVAh	Watt*2	Voltage	Current	Power Factor* 2	Kvar*2	Total Kvarh
ROOT(L1+L2+L3) *1	✓	✓	✓	✗	✗	✓	✓	✓
Endpoint 1 (L1+L2+L3)	✓	✓	✓	✗	✗	✓	✓	✓
Endpoint 2 – L1	✗	✗	✓	✓	✓	✓	✓	✗
Endpoint 3 – L2	✗	✗	✓	✓	✓	✓	✓	✗
Endpoint 4 – L3	✗	✗	✓	✓	✓	✓	✓	✗

*1NOTE: ENDPOINT1 is a copy of ROOT. ROOT is used in single channel configuration. For the correct display of all values multichannel lifeline has to be used.

*²NOTE : Values are report in the negative value

*³NOTE: Values on 3-phase smart meter display is the sum of import (Watt, PF,Kvar) and export (Watt, PF,Kvar)NOTE: there could be a meter measurement update delay for some scales up to 10 minutes. Therefore the first real measured values could be reported with the same delay. Check for details description of par.42&43

DIMENSIONAL DRAWING:

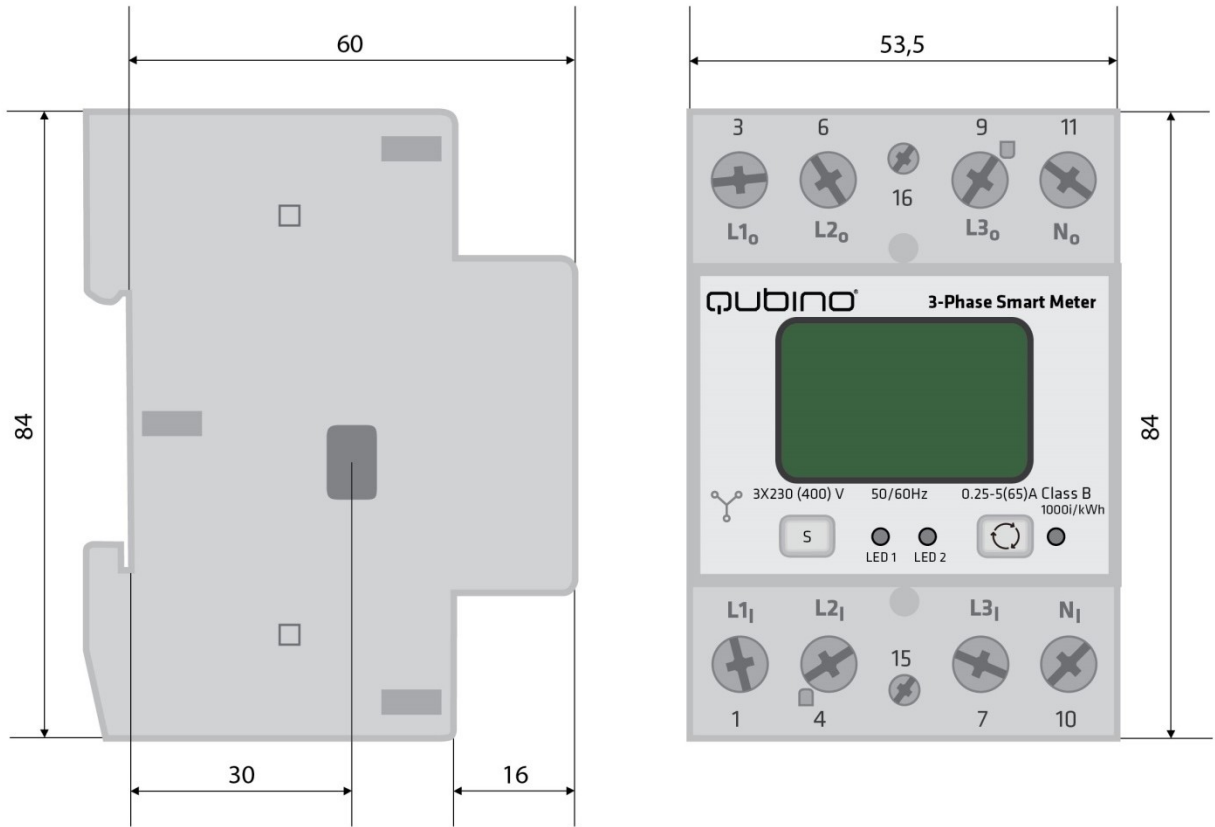

EXTERNAL RELAYS:

It is possible to connect two external relays to 3-Phase Smart Meter device. One controlled by built-in optical (IR) communication port on the side, second controlled by output on terminal 15.

* IKA and BICOM are sold separately - for more info, please see Qubino catalogue. Product ordering codes (model numbers): IKA232-20/230V: 030 046 833 000; BICOM432-40-WM1: 30.074.038

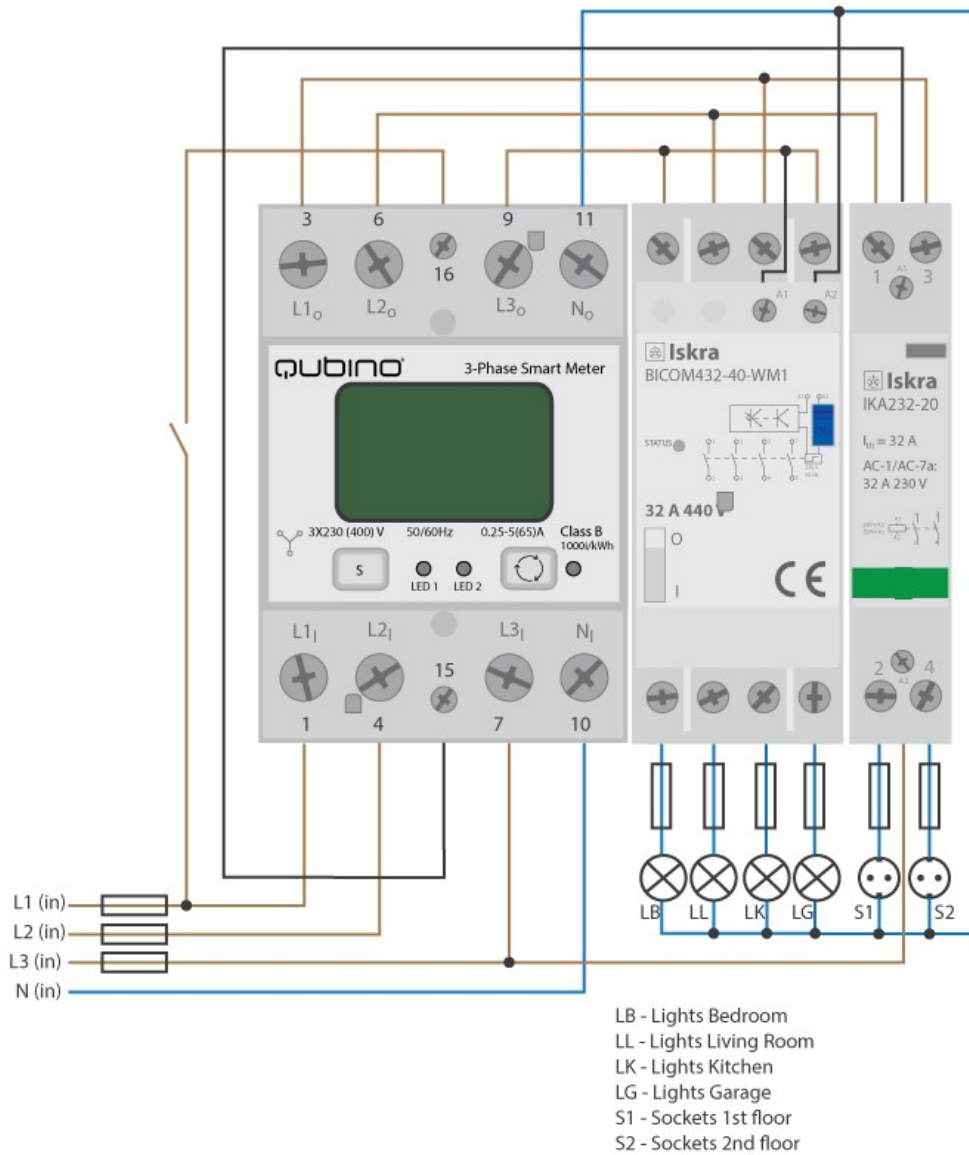

BICOM432-40-WM1 (IR) RELAY

BICOM432-40-WM1 is a bistable switch with modbus communication over IR connection. Bistable switch is a switching device with two stable states for switching on and off all kinds of electrical loads. When the switch is not electrically, manually or over a IR communication path, remains stable in its operating position and will change its operating position on initiation or actuation. initiated Switch is controllable over a IR communication interface always in a slave communication position. BICOM432-40-WM1 has built-in electro-mechanical check of the position status. BICOM432-40-WM1 is available as standalone unit, being also powered from own power source over an internal power supply. By default, endpoint 3, which corresponds to this relay, is hidden and can be enabled by changing the value of the configuration parameter 100.

For more information, please consult the official manual, which can be obtained on the following address: <http://qubino.com/download/1107/>

IKA232-20/230V

IKA232-20 is a external switch, which can be controlled, in contrast to the IR relay, using a digital output (on the 3-Phase Smart Meter).. It can can be used for remote control of various AC devices (fast switching of motors, electric heating, lights and lightning, all kinds of electrical and electronic equipment, which can be found in residential, hospitals, hotels, and business premises). IKA232-20/230V is available as standalone unit, being also powered from own power source over an internal power supply. By default, endpoint 2, which corresponds to this relay, is hidden and can be enabled by changing the value of the configuration parameter 101.

For more information, please consult the official manual, which can be obtained on the following address: <http://qubino.com/download/1099/>

Both relays can be controlled using the supported actuation commands: BASIC_SET, SWITCH_BINARY_SET

10. Adding the device to a Z-Wave network (Inclusion)

AUTOMATICALLY ADDING THE DEVICE TO A Z-WAVE NETWORK (AUTO INCLUSION)

1. Enable add/remove mode on your Z-Wave gateway (hub)
2. Automatic selection of secure/unsecure inclusion
3. The device can be automatically added to a Z-Wave network during the first 2 minutes
4. Connect the device to the power supply
5. Auto-inclusion will be initiated within 5 seconds of connection to the power supply and the device will be automatically added to your network (when the device is excluded and re-connected to the power supply it automatically enters the LEARN MODE state.)

 NOTE: For S2 inclusion please check chapter – »16. Z-Wave Security«.

MANUALLY ADDING THE DEVICE TO A Z-WAVE NETWORK (MANUAL INCLUSION)

1. Connect the device to the power supply
2. Enable add/remove mode on your Z-Wave gateway (hub)
3. Toggle the Service button S between 0.2 and 3 seconds
4. A new multi-channel device will appear on your dashboard
5. Inclusion with the S service button is not limited by time

11. Removing the device from a Z-Wave network (Exclusion)

REMOVAL FROM A ZWAVE NETWORK (Z-WAVE EXCLUSION)

1. Connect the device to the power supply
2. Make sure the device is within direct range of your Z-Wave gateway (hub) or use a hand-held Z-Wave remote to perform exclusion
3. Enable add/remove mode on your Z-Wave gateway (hub)
4. Press and hold the S service button between 0.2 and 3 seconds
5. Exclusion with the S service button is not limited by time
6. The device will be removed from your network but custom configuration parameters will not be erased. Wait at least 30 seconds before adding the device back to a network.

FACTORY RESET

1. Connect the device to the power supply
2. Press and hold the S service button between 6 seconds and 20 seconds
3. Device will be removed from you network and the green LED starts blinking

 By resetting the device, all custom parameters previously set on the device will return to their default values, and the owner ID will be deleted. Use this reset procedure only when the main gateway (hub) is missing or otherwise inoperable.

LED SIGNALIZATION FOR INCLUSION/EXCLUSION

LED1 (Green)

- LED is ON = Power ON, module is included
- LED is 1s OFF, 1s ON = Power ON, module is excluded

LED2 (Yellow)

- a. External IR relay enabled only
 - LED is ON = External IR relay is turned ON
 - LED is OFF = External IR relay is turned OFF
 - LED is 0.5s OFF, 0.5s ON = IR communication error
- b. External TRIAC relay enabled only
 - LED is ON = External IR relay is turned ON
 - LED is OFF = External IR relay is turned OFF
- c. Both TRIAC an IR enabled
 - LED is ON = External IR relay is turned ON
 - LED is OFF = External IR relay is turned OFF
 - LED is 0.5s OFF, 0.5s ON = IR communication error
- d. External IR relay disabled
 - LED is ON = modbus packet is sent
 - LED is OFF = modbus packet is received

NOTE: While there's no external relay the yellow led will result blinking as the modbus packages are sent and received all the time.

12. Associations

Use associations for direct communication between the 3-Phase Smart Meter and other devices within your Z-Wave network without the need of your primary gateway (hub).

Association Groups:

- Group 1: Lifeline group (reserved for communication with the gateway (hub)), 1 node allowed.

Root device:

Group ID	Name	Allowed nodes	Description
1	Lifeline	1	Supports the following command classes: <ul style="list-style-type: none"> • Device Reset Locally: triggered upon request • Meter Report: triggered according to Configuration parameters 40,42 and 43 • Switch Binary Report: triggered upon change of relay state

Endpoint 1:

Group ID	Name	Allowed nodes	Description
1	Lifeline	0	Supports the following command classes: <ul style="list-style-type: none"> • Meter Report: triggered according to Configuration parameters 40,42 and 43 • Switch Binary Report: triggered upon change of relay state

Endpoint 2:

Group ID	Name	Allowed nodes	Description
1	Lifeline	0	Supports the following command classes: <ul style="list-style-type: none"> • Meter Report: triggered according to Configuration parameters 40,42 and 43 • Switch Binary Report: triggered upon change of relay state

Endpoint 3:

Group ID	Name	Allowed nodes	Description
1	Lifeline	0	Supports the following command classes: <ul style="list-style-type: none">• Meter Report: triggered according to Configuration parameters 40,42 and 43• Switch Binary Report: triggered upon change of relay state

Endpoint 4:

Group ID	Name	Allowed nodes	Description
1	Lifeline	0	Supports the following command classes: <ul style="list-style-type: none">• Meter Report: triggered according to Configuration parameters 40,42 and 43• Switch Binary Report: triggered upon change of relay state

13. Configuration Parameters

Parameter no. 7 – Input switch function selection

Available configuration parameters for input switch

Values (size is 1 byte dec):

Default value 0

- 0 – disabled
- 2 – IR external relay control – mono stable push button
- 3 – IR external relay control – bi-stable switch
- 4 – External relay control – mono stable push button
- 5 – External relay control – bi-stable switch

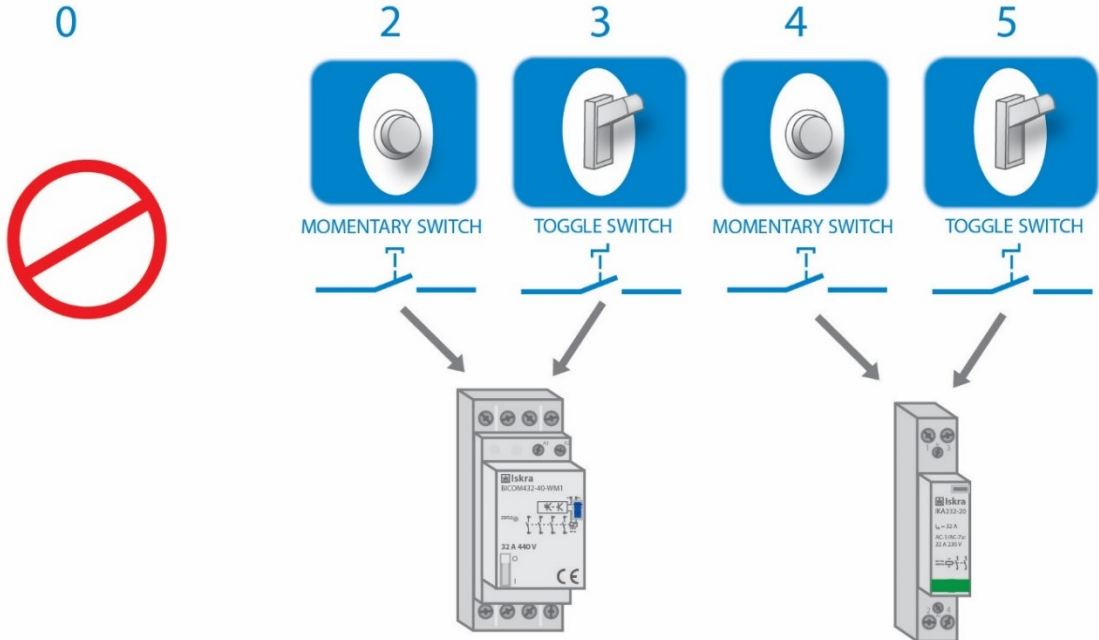

Note!

- By setting the parameter 7 to value 4 or 5 the external Relay (IKA) is working with input switch without enabling parameter no. 101
- To make the IR Relay (BICOM) responsive to the digital input, in addition to the setting of the configuration parameter 7, parameter 100 must also be set to value 1 or 2.

Parameter no. 40 –Reporting on power change

This parameter is valid for Active Power Total, Active Power Phase1, Active Power Phase2 and Active Power Phase3.

Set value means percentage from 0-100 = 0% - 100%

- Available configuration parameters (data type is 1 Byte DEC)
 - Default value 50
 - 0 – reporting disabled
 - 1-100 = 1% - 100% reporting enabled. Power report is send only when actual power in Watts (in real time changes for more than set percentage comparing to previous Active Power, step is 1%.

NOTE: if power change is less than 5 W, the report is not send (pushed).

NOTE: Device is measuring also some disturbances even if on the output is no load. To avoid disturbances:

- If measured Active Power (W) is below e.g. 5W-> the reported value in this case is 0W

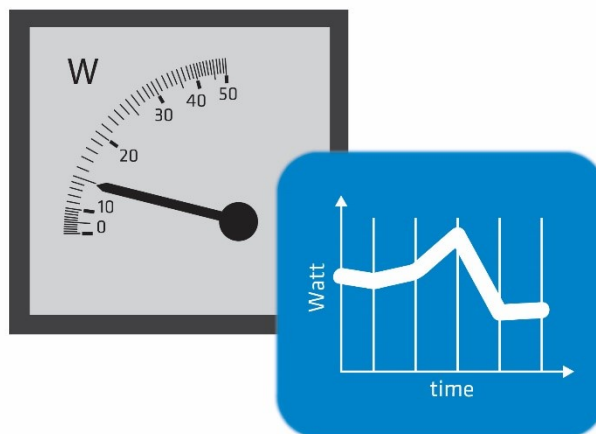

Parameter no. 42 – Reporting on time interval

This parameter is currently valid only for Active Energy Total Import/Export (kWh), Reactive Energy Total (kvarh), Total Energy (kVAh)

- Available configuration parameters (data type is 2 Byte DEC)
 - Default value 600 (600 seconds - 10 minutes)
 - 0 – reporting disabled
 - 30-32535 = 30 (30 seconds – 32535 seconds). Reporting enabled. Report is send with the time interval set by entered value.

Note: Device is reporting only if there was a change of 0.1 in Energy

Note: In the future will be possible to measure and report also Active Energy on PH1, PH2 and PH3.

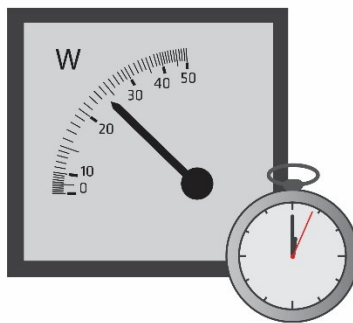

Parameter no. 43 – Other Values - Reporting on time interval

This parameter is valid only for Voltage (V of ph1, ph2, ph3), Current (A of ph1, ph2, ph3), Total Power Factor, Total Reactive Power (var)

Available configuration parameters (data type is 2 Byte DEC)

- Default value 600 (600 seconds - 10 minutes)
- 0 – reporting disabled
- 30-32535 = 30 (30 seconds – 32535 seconds). Reporting enabled. Report is send with the time interval set by entered value.
- Note: Device is reporting only if there was a change

Parameter no. 100 – Enable / Disable External IR relay (BICOM)

Available configuration parameters (data type is 1 Byte DEC):

- default value 0
- 0 – External IR relay disabled
- 1 – External IR relay enabled and connected to all 3 Phases
- 2 – External IR relay enabled and connected to a Phase 1

NOTE1: After parameter change, first exclude module (without setting parameters to default value) and then re include the module.

NOTE 2: If you don't have IR BICOM relay module mounted and you enable IR communication (parameter 100 is 1 or 2) there will be no valid IR relay state reported. It will be reported IR COMMUNICATION ERROR and LED2 will BLINK.

Parameter no. 101 – Enable / Disable External relay (IKA)

Available configuration parameters (data type is 1 Byte DEC):

- default value 0
- 0 – External relay disabled
- 1 – External relay enabled and connected to Phase 2

NOTE1: After parameter change, first exclude module (without setting parameters to default value) and then re include the module.

Parameter no. 106 – External IR relay (BICOM) power threshold settings – maximum power of all phases together

This parameter defines a threshold when External IR relay is being turned off. (If Parameter no. 100 is set to the value 1 or 2)

- Available configuration parameters (data type is 2 Byte DEC)
 - Default value 0
 - 0 – no function
 - 10-60000 – 10W-60000W

NOTE: Meter is capable of measuring max 3x65A!

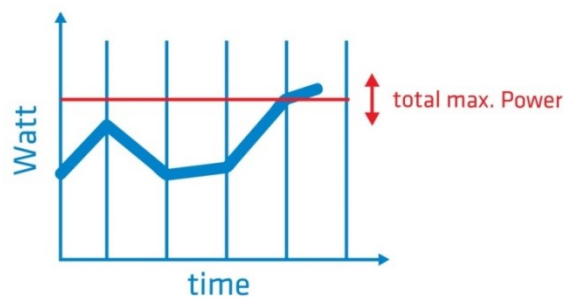
**Parameter no. 107 – External relay (IKA) power threshold settings – maximum power on phase L2**

This parameter defines a threshold when External relay is being turned off (if the parameter no. 100 is set to the value 1 or 2).

Available configuration parameters (data type is 2 Byte DEC)

- Default value 0
- 0 – no function
- 10-20000 – 10W-20000W

NOTE: Meter is capable of measuring max 65A

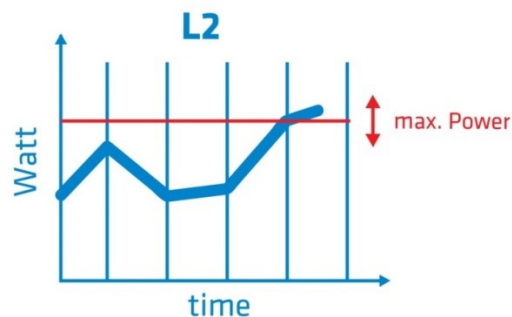

Parameter no. 112 – Power threshold – Delay before power on

External IR relay/ External relay is turned off due to detected overload (as set by parameter 106&107) and remains off for a time, defined in this parameter. After that time, the output turns on to check, if the overload is still present.

Available configuration parameters (data type is 2 Byte DEC)

- Default value 0 (disabled)
- 0 – External IR relay/ External relay will not turn back on
- 30 – 32535 = 30 s – 32535 s

NOTE: the delay time may be prolonged for more than 10s of the time set by the parameter.

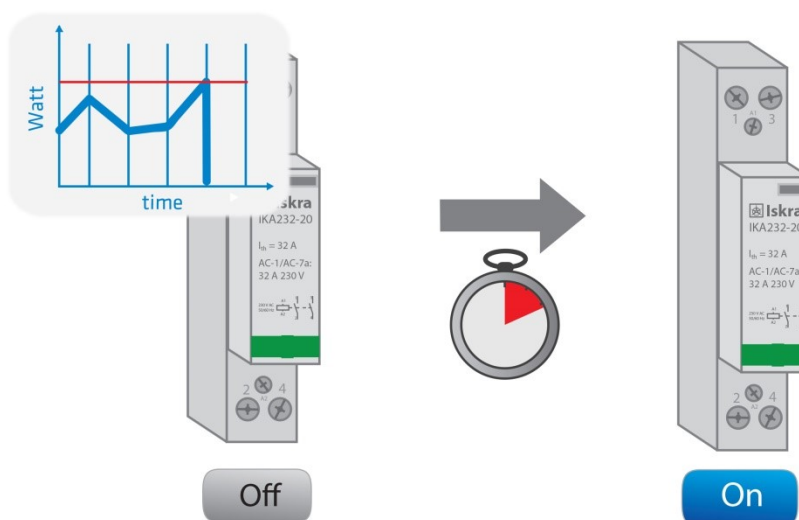

14. Technical Specifications

Main terminals (L1I, L2I, L3I, NO, L1O, L2O, L3O, NO)	
Contacts capacity:	2.5 ... 16 (25) mm ²
Connection screws:	M5
Max torque:	3.5 Nm (PZ2)
Optional terminals (1,2,4,5)	
Contact capacity:	1 ... 2.5 mm ²
Screws:	M3
Max torque:	1.2 Nm
Measuring input:	
Type (connection):	three phase (4u)
Reference current (I _{ref}):	5 A
Maximum current (I _{max}):	65 A
Minimum current (I _{min}):	0.25 A
Starting current:	20 mA
Reference voltage (U _n):	3x230 V/400V
Power consumption at U _n :	< 8 VA
Nominal frequency (f _n):	50 and 60 Hz
Accuracy:	
Active energy and power:	
Standard EN 62053-21:	class 1
Standard EN 50470-3:	class B

Reactive energy:	
Standard EN 62053-23:	class 2
LED:	
Colour:	red
Pulse rate:	1000 imp/kWh
LED on:	No load indication
Optical communication:	
Type:	IR - used to control BICOM432-40-IR
Input (16):	
Rated voltage:	230 V ($\pm 20\%$)
Input resistance:	450 kOhm
Safety:	
Indoor Meter:	yes
Degree of pollution:	2
Protection class:	II
AC voltage test:	4 kV
Installation Category:	300 Vrms cat. III
Standard:	EN 50470
Ambient conditions and EMC:	
According standards for indoor active energy Meters.	
Temperature and climatic condition according to EN 62052 11	
Ambient conditions and Safety:	

According standards for indoor active energy Meters.	
Temperature and climatic condition according to EN 62052 11	
Dust/water protection:	IP50
Operating temperature:	-25 ... 55°C
Storage temperature:	-40 ... 70°C
Enclosure material:	self-extinguish complying UL94 V
Indoor Meter:	yes
Degree of pollution:	2
AC voltage test:	4 kV
Standard:	EN 50470
Distance:	up to 30 m indoors (depending on building materials)
Weight (with packaging):	220g (240g)
Frequency range:	868.4 MHz*, Z-Wave
Installation	Din rail 35mm
Dimensions (W x H x D):	53,6 x 84 x 65mm
Package dimensions (W x H x D):	58 x 84 x 95mm
Colour	RAL 7035

*Depends on ordering code

15. Z-Wave Command Classes

ROOT DEVICE

DEVICE CLASS:

GENERIC TYPE: GENERIC_TYPE_METER

SPECIFIC TYPE: SPECIFIC_TYPE_WHOLE_HOME_METER_SIMPLE

SUPPORTED Z-Wave COMMAND CLASSES:

COMMAND_CLASS_ZWAVEPLUS_INFO_V2

COMMAND_CLASS_TRANSPORT_SERVICE_V2

COMMAND_CLASS_SECURITY_V1

COMMAND_CLASS_SECURITY_2_V1

COMMAND_CLASS_SUPERVISION

COMMAND_CLASS_CRC_16_ENCAP

COMMAND_CLASS_DEVICE_RESET_LOCALLY [S2]*

COMMAND_CLASS_POWERLEVEL [S2]*

COMMAND_CLASS_VERSION_V2 [S2]*

COMMAND_CLASS_MANUFACTURER_SPECIFIC_V2 [S2]*

COMMAND_CLASS_CONFIGURATION_V1 [S2]*

COMMAND_CLASS_ASSOCIATION_V2 [S2]*

COMMAND_CLASS_MULTI_CHANNEL_ASSOCIATION_V3 [S2]*

COMMAND_CLASS_ASSOCIATION_GRP_INFO_V2 [S2]*

COMMAND_CLASS_METER_V4 [S2]*

COMMAND_CLASS_FIRMWARE_UPDATE_MD_V4 [S2]*

COMMAND_CLASS_BASIC_V1 [S2]* (not listed in NIF - only if one of the relays is enabled)

COMMAND_CLASS_SWITCH_BINARY_V1 [S2]* (only if one of the relays is enabled)

End Point 1 (Root copy, aggregated values)**DEVICE CLASS:**

GENERIC TYPE: GENERIC_TYPE_METER

SPECIFIC TYPE: SPECIFIC_TYPE_WHOLE_HOME_METER_SIMPLE

SUPPORTED Z-Wave COMMAND CLASSES:

COMMAND_CLASS_ZWAVEPLUS_INFO_V2

COMMAND_CLASS_SECURITY_V1

COMMAND_CLASS_SECURITY_2_V1

COMMAND_CLASS_SUPERVISION_V1

COMMAND_CLASS_ASSOCIATION_V2 [S2]*

COMMAND_CLASS_MULTI_CHANNEL_ASSOCIATION_V3 [S2]*

COMMAND_CLASS_ASSOCIATION_GRP_INFO_V2 [S2]*

COMMAND_CLASS_METER_V4 [S2]*

COMMAND_CLASS_BASIC_V1 [S2]* (not listed in NIF - only if one of the relays is enabled)

COMMAND_CLASS_SWITCH_BINARY_V1 [S2]* (only if one of the relays is enabled)

End Point 2 (Phase 1)**DEVICE CLASS:**

GENERIC TYPE: GENERIC_TYPE_METER

SPECIFIC TYPE: SPECIFIC_TYPE_WHOLE_HOME_METER_SIMPLE

SUPPORTED Z-Wave COMMAND CLASSES:

COMMAND_CLASS_ZWAVEPLUS_INFO_V2

COMMAND_CLASS_SECURITY_V1

COMMAND_CLASS_SECURITY_2_V1

COMMAND_CLASS_SUPERVISION_V1

COMMAND_CLASS_ASSOCIATION_V2 [S2]*

COMMAND_CLASS_MULTI_CHANNEL_ASSOCIATION_V3 [S2]*

COMMAND_CLASS_ASSOCIATION_GRP_INFO_V2 [S2]*

COMMAND_CLASS_METER_V4 [S2]*

End Point 3 (Phase 2)

DEVICE CLASS:

GENERIC TYPE: GENERIC_TYPE_METER

SPECIFIC TYPE: SPECIFIC_TYPE_WHOLE_HOME_METER_SIMPLE

SUPPORTED Z-Wave COMMAND CLASSES:

COMMAND_CLASS_ZWAVEPLUS_INFO_V2

COMMAND_CLASS_SECURITY_V1

COMMAND_CLASS_SECURITY_2_V1

COMMAND_CLASS_SUPERVISION_V1

COMMAND_CLASS_ASSOCIATION_V2 [S2]*

COMMAND_CLASS_MULTI_CHANNEL_ASSOCIATION_V3 [S2]*

COMMAND_CLASS_ASSOCIATION_GRP_INFO_V2 [S2]*

COMMAND_CLASS_METER_V4 [S2]*

End Point 4 (Phase 3)

DEVICE CLASS:

GENERIC TYPE: GENERIC_TYPE_METER

SPECIFIC TYPE: SPECIFIC_TYPE_WHOLE_HOME_METER_SIMPLE

SUPPORTED Z-Wave COMMAND CLASSES:

COMMAND_CLASS_ZWAVEPLUS_INFO_V2

COMMAND_CLASS_SECURITY_V1

COMMAND_CLASS_SECURITY_2_V1

COMMAND_CLASS_SUPERVISION_V1

COMMAND_CLASS_ASSOCIATION_V2 [S2]*

COMMAND_CLASS_MULTI_CHANNEL_ASSOCIATION_V3 [S2]*

COMMAND_CLASS_ASSOCIATION_GRP_INFO_V2 [S2]*

COMMAND_CLASS_METER_V4 [S2]*

End Point 5 (External Relay)

DEVICE CLASS:

GENERIC TYPE: GENERIC_TYPE_SWITCH_BINARY

SPECIFIC TYPE: SPECIFIC_TYPE_POWER_SWITCH_BINARY

SUPPORTED Z-Wave COMMAND CLASSES:

COMMAND_CLASS_ZWAVEPLUS_INFO_V2

COMMAND_CLASS_SECURITY_V1

COMMAND_CLASS_SECURITY_2_V1

COMMAND_CLASS_SUPERVISION_V1

COMMAND_CLASS_ASSOCIATION_V2 [S2]*

COMMAND_CLASS_MULTI_CHANNEL_ASSOCIATION_V3 [S2]*

COMMAND_CLASS_ASSOCIATION_GRP_INFO_V2 [S2]*

COMMAND_CLASS_METER_V4 [S2]*

End Point 6 (External IR Relay)**DEVICE CLASS:**

If External relay is not connected, this endpoint has a number 5

GENERIC TYPE: GENERIC_TYPE_SWITCH_BINARY

SPECIFIC TYPE: SPECIFIC_TYPE_POWER_SWITCH_BINARY

SUPPORTED Z-Wave COMMAND CLASSES:

COMMAND_CLASS_ZWAVEPLUS_INFO_V2

COMMAND_CLASS_SECURITY_V1

COMMAND_CLASS_SECURITY_2_V1

COMMAND_CLASS_SUPERVISION_V1

COMMAND_CLASS_ASSOCIATION_V2 [S2]*

COMMAND_CLASS_MULTI_CHANNEL_ASSOCIATION_V3 [S2]*

COMMAND_CLASS_ASSOCIATION_GRP_INFO_V2 [S2]*

COMMAND_CLASS_METER_V4 [S2]*

COMMAND_CLASS_BASIC_V1 [S2]* (not listed in NIF - only if one of the relays is enabled)

COMMAND_CLASS_SWITCH_BINARY_V1 [S2]* (only if one of the relays is enabled)

*[S2] Security S2 Command Class

NOTE:

* Command classes on endpoints are supported securely only if the device is added to a Z-Wave network as secure.

NOTE:

- Endpoints are shown/hidden by Parameter No. 100 and 101
- The relays will be turned ON or OFF after receiving the BASIC_SET command.
- To be turned ON: [Command Class Basic, Basic Set, Basic Value = 0x01~0x63; FF]
- To be turned OFF: [Command Class Basic, Basic Set, Basic Value = 0x00]
- BASIC SET/GET on root device is mapped to basic set/get of both endpoints.

COMMAND_CLASS_METER_V1

- Default values:
 - Rate Type = 1 (Import)
 - Scale = 0 (W)

This Security Enabled Z-Wave Plus Product can be included and operated in any Z-Wave network with other Z-Wave certified devices from any other manufacturers and product categories. All constantly powered nodes in the same network will act as repeaters regardless of the vendor in order to increase reliability of the network.

16. Z-Wave Security

Qubino Smart Meter supports the latest Security 2 feature. Security S2 is handled by the Strong AES 128 Encryption protocol, which means that the S2 makes Z-Wave the most secure IoT (Internet of Things) security platform out there. In order to fully utilize the product and its SECURITY 2 feature, a Security Enabled Z-Wave gateway (hub) must be used.

Authenticated Control

- Out-Of-Band Device Specific Key for inclusion
- May be used by most implementations

Also supports: Security S2 Unauthenticated and Unsecure inclusion.

IMPORTANT: When adding the Smart Meter to a Z-Wave network with a controller supporting Security 2 (S2), the Z-Wave Device Specific Key (DSK) is required. The unique DSK code is printed on the side label of the product and a copy is inserted in the packaging, which must not be lost. Do not remove the DSK from the product. As a backup measure, please use the label in the packaging to record the location where the product has been installed.

The first five digits of key is highlighted or underlined to help the user identify the PIN code portion of the DSK text.

The DSK is additionally represented with a QR Code as shown here.

DSK label and QR code (example)



A joining node requesting to join the S2 Access Control Class or the S2 Authenticated Class will obfuscate its Public Key by setting the bytes 1...2 to zeros (0x00) before transferring its key via RF.

A joining node requesting to join only the S2 Unauthenticated Class will send the its full Public Key when transferring the key via RF as the including node has no access to the DSK.

The DSK may be used for out-of-band (OOB) authentication in two ways.

- The including gateway (hub) may use QR code scanning to read the entire DSK off the joining device and match it with the obfuscated public key received via RF from the joining device.

- Else the including gateway (hub) will ask the user to enter a 5 digits PIN code (the 5 first digits of the DSK label) in order to substitute the obfuscated bytes of the joining node's Public Key. The including gateway (hub) may additionally ask the user to visually validate that the rest of the DSK with the Public Key received via RF.

17. Important Disclaimer

Z-Wave wireless communication is not always 100% reliable. This device should not be used in situations in which life and/or valuables are solely dependent on its functioning. If the device is not recognized by your gateway (hub) or shows up incorrectly, you may need to change the device type manually and make sure your gateway (hub) supports multi-channel devices. Contact us for help before returning the device: <http://qubino.com/support/#email>

18. Warning

Do not dispose of electrical appliances as unsorted municipal waste, use separate collection facilities. Contact your local government for information regarding the collection systems available. If electrical appliances are disposed of in landfills or dumps, hazardous substances can leak into the groundwater and get into the food chain, damaging your health and well-being. When replacing old appliances with new ones, the retailer is legally obligated to take back your old appliance for disposal free of charge.

19. Regulations

Legal Notice

This user manual is subject to change and improvement without notice. GOAP d.o.o. Nova Gorica reserves all rights to revise and update all documentation without any obligation to notify any individual or entity.

Declaration of Conformity

Qubino 3-Phase Smart Meter device is in compliance with the essential requirements and other relevant provisions of the Low voltage (LVD) Directive (2014/35/EU), Electromagnetic Compatibility (EMC) Directive (2014/30/EU), Radio Equipment Directive (2014/53/EU), Directive RoHS 2 (2011/65/EU) and Directive ErP (2009/125/EC).

WEEE

According to the WEEE (Waste electrical and electronic equipment) Directive, do not dispose of this product as household waste or commercial waste. Waste electrical and electronic equipment should be appropriately collected and recycled as required by practices established for your country. For information on recycling of this product, please contact your local authorities, your household waste disposal service or the shop where you purchased the product.



NOTE: User manual is valid for device with the S5 (SW version is part of P/N)!

Example: P/N: ZMNHXDx H1S5P2

GOAP d.o.o. Nova Gorica

Ulica Klementa Juga 007, 5250 Solkan, Slovenia

E-mail: info@qubino.com

Tel: +386 5 335 95 00

Web: www.qubino.com

Date: 08.01.2021; V50.06.1

[DON'T MISS OTHER INVENTIONS FROM QUBINO– CLICK HERE AND CHECK OUT QUBINO'S COMPLETE PORTFOLIO](#)